

5J SERIES 2XN LED JACK H=31.23

HY5JB88-2X1XXXX

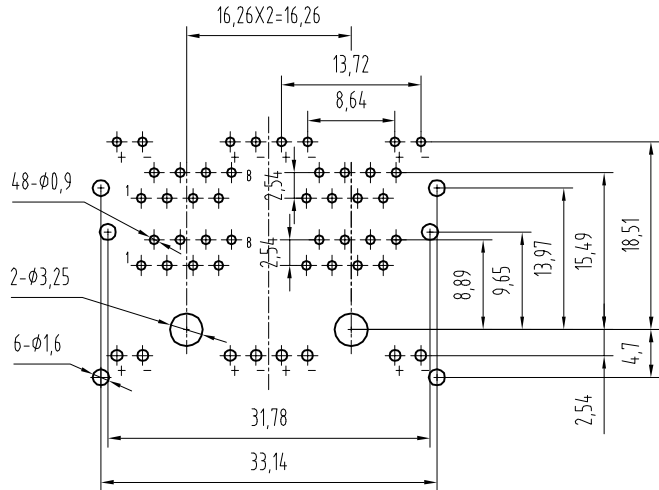
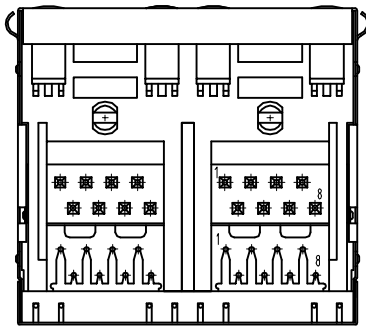
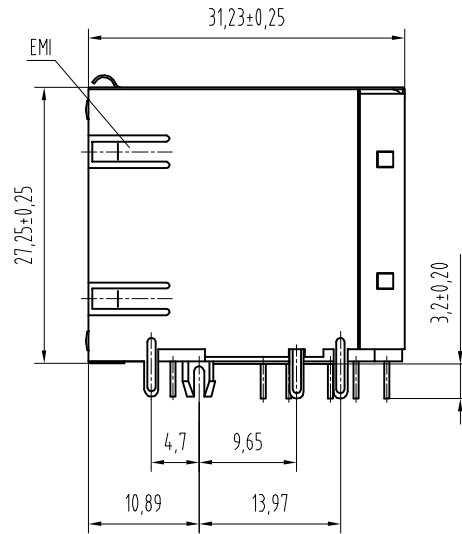
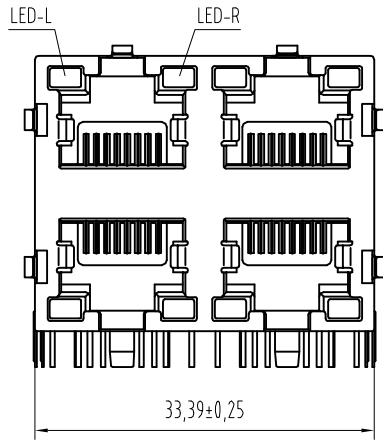

PC Board Layout
Component Side Shown

ORDERING INFORMATION

